

IVC1L-5AM Analog I/O Module

User Manual

Thank you for using INVT programmable logic controller (PLC). Before using the IVC1L series PLC product, please carefully read this booklet so as to better understand it, fully use it, and ensure safety.

1 Port Description

1.1 Port

The extension port and user port of IVC1L-5AM are both protected by a cover, as shown in Figure 1-1. Removing the covers reveals the extension port and user port, as shown in Figure 1-2.

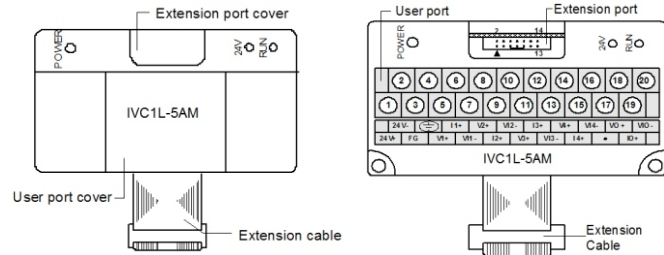

Figure 1-1 IVC1L-5AM appearance Figure 1-2 IVC1L-5AM Ports

The extension cable connects IVC1L-5AM to the system, while the extension port connects IVC1L-5AM to another extension module of the system. For details on connection, see 1.2 Connecting Into System.

The user port of IVC1L-5AM is described in Table 1-1.

Table 1-1 User port description

Terminal	Name	Description
1	24V+	Analog power supply 24V+
2	24V-	Analog power supply 24V-
3	FG	Shielding ground
4	PG	Protection ground
5, 8, 11, 14	V1+~V4+	CH1~CH4 voltage input
6, 9, 12, 15	I1+~I4+	CH1~CH4 current input
7, 10, 13, 16	VI1~VI4-	CH1~CH4 signal input
17	●	NC
18	VO+	Output channel voltage output
19	IO+	Output channel current output
20	VIO-	Common GND of output channel

Note: an input channel cannot receive both voltage signals and current signals at the same time. If you intend to use a channel for current signal measurement, short its voltage input terminal and current input terminal.

1.2 Connecting Into System

Through the extension cable, you can connect IVC1L-5AM to IVC1L series basic module or other extension modules. While through the extension port, you can connect other IVC1L series extension modules to IVC1L-5AM. See Figure 1-3.

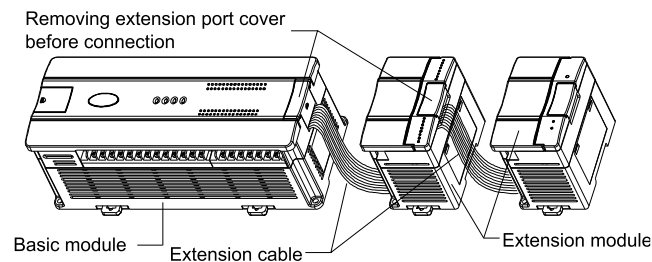

Figure 1-3 Connecting IVC1L-5AM to the basic module

1.3 Wiring

The wiring of user port is shown in Figure 1-4.

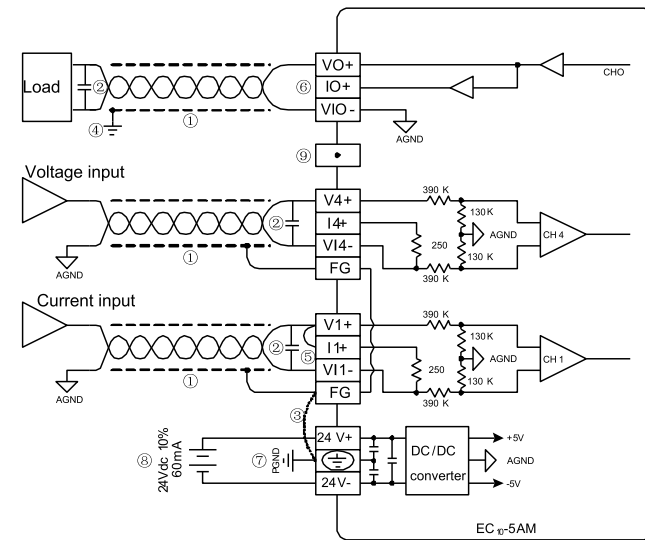

Figure 1-4 Wiring of IVC1L-5AM user port

The circled 1~9 stands for the six points to be observed during wiring:

1. It is recommended to use shielded twisted pair for the analog input and output. Route them separate from power cables or any cables that may generate EMI.
2. If the I/O signal has electric noise or voltage fluctuation, it is advisable to connect a smoothing capacitor (0.1μF~0.47μF/25V).
3. If strong EMI exists, connect the FG and PG terminals together.
4. Each load of the PLC should be grounded separately.
5. If a channel is used for current input, short its voltage input terminal and current input terminal.
6. Shorting the voltage output terminals or connecting current load to the voltage output terminals may damage IVC1L-5AM.
7. Properly ground the module's PG terminal.
8. The basic module's 24Vdc output power or any qualified external power supply can be used as the power source of the module's analog circuit.
9. Do not use the NC terminal of the user port.

2 Indices

2.1 Power Supply

Table 2-1 Power supply

Item	Description
Analog circuit	24Vdc (-15% ~ 20%), maximum allowable ripple voltage 5%, 90mA (from basic module or external power supply)
Digital circuit	5Vdc 50mA (from basic module)

2.2 Performance

Table 2-2 Performance

Item	Index	
Conversion speed	AD conversion	15ms/channel (normal), 8ms/channel (high speed)
	DA conversion	2ms/channel (max.)
Analog input range	Voltage	-10~10Vdc (input impedance 1MΩ) *Warning: this module can be damaged if the input voltage exceeds ±15Vdc
	Current	-20~20mA (input impedance 250Ω) *Warning: this module can be damaged if the input current exceeds ±32mA
Analog output range	Voltage	-10~10Vdc (external load impedance ≥2kΩ)
	Current	0~20mA (external load impedance ≤520Ω)
Digital output	Default: -2000 ~ 2000 Setting range: -10000~10000	
Digital input	Default: -2000~2000 Setting range: -10000~10000	

Item	Index	
Resolution	Voltage input	5mV
	Current input	10μA
	Voltage output	5mV
	Current output	10μA
Accuracy	Analog input	±1% of full range
	Analog output	±1% of full range
Isolation	Between analog circuit and digital circuit: photocoupler. Between analog circuit and input 24Vdc power: internal isolation. Between analog channels: none	

2.3 Buffer Memory

IVC1L-5AM exchanges data with the basic module through Buffer Memory (BFM). After IVC1L-5AM is set through the host software, the basic module will write data into IVC1L-5AM BFM to set the state of IVC1L-5AM and display the data from IVC1L-5AM on the host software interface. See Figure 4-1 and Figure 4-1.

Table 2-3 describes the contents of IVC1L-5AM BFM.

Table 2-3 BFM Contents

BFM	Contents	Description and default	Property
#000	CHO channel data	Output channel	RW
#100	Average value of CH1	Input channel	R
#101	Average value of CH2	Input channel	R
#102	Average value of CH3	Input channel	R
#103	Average value of CH4	Input channel	R
#200	Current value of CH1	Input channel	R
#201	Current value of CH2	Input channel	R
#202	Current value of CH3	Input channel	R
#203	Current value of CH4	Input channel	R
#300	Module error state word		R
#600	Input channel model word	0x0000	RW
#650	output channel model word	0x0000	RW
#700	Average sampling times of CH 1	8	RW
#701	Average sampling times of CH2	8	RW
#702	Average sampling times of CH3	8	RW
#703	Average sampling times of CH4	8	RW
#900	CHO-D0	0 (output mode 0)	RW
#901	CHO-A0	0 (output mode 0)	R
#902	CHO-D1	2000 (output mode 0)	RW
#903	CHO-A1	10000 (output mode 0)	R
#904	CH1-D0	0 (input mode 0)	RW
#905	CH1-A0	0 (input mode 0)	R
#906	CH1-D1	2000 (input mode 0)	RW
#907	CH1-A1	10000 (input mode 0)	R
#908	CH2-D0	0 (input mode 0)	RW
#909	CH2-A0	0 (input mode 0)	R
#910	CH2-D1	2000 (input mode 0)	RW
#911	CH2-A1	10000 (input mode 0)	R
#912	CH3-D0	0 (input mode 0)	RW
#913	CH3-A0	0 (input mode 0)	R
#914	CH3-D1	2000 (input mode 0)	RW
#915	CH3-A1	10000 (input mode 0)	R
#916	CH4-D0	0 (input mode 0)	RW
#917	CH4-A0	0 (input mode 0)	R
#918	CH4-D1	2000 (input mode 0)	RW
#919	CH4-A1	10000 (input mode 0)	R
#2000	AD conversion speed switchover	0 (15ms/CH)	RW
#2100	Channel reset	0x0000	RW
#4094	Module software version	0x1000	R
#4095	Module ID	0x3141	R

Explanation:

1. CH1 stands for channel 1; CH2, channel 2; CH3, channel 3, and so on.
2. Property explanation: R means read only. An R element cannot be written. RW means read and write. Reading from a non-existent element will get 0.
3. Status information of BFM#300 is shown in Table 2-4.

Table 2-4 BFM#300 status information

Bit status of BFM#300	ON (1)	OFF (0)
b0: error	b1 or b2 is ON, AD/DA conversion of all channels stopped	No error
b1: deviation, gain error	Channel characteristics setting error in BFM	Deviation/gain data normal
b2: power supply failure	24Vdc power supply failed	Power supply normal
b3: hardware fault	AD/DA converter or other hardware faulty	Hardware normal
b10: digital range error	1. Digital output after AD conversion outside the range of -2048~+2047; 2. Digital input for DA conversion outside specified range	Digital input/output value normal
b11: average sampling times setting error	Setting outside normal range (in this case, the default 8 will be used)	Setting within normal range: 1 ~ 4096

4. BFM#600: input mode selection, used to set the input modes of CH1~CH4. See Figure 2-1 for their correspondence.

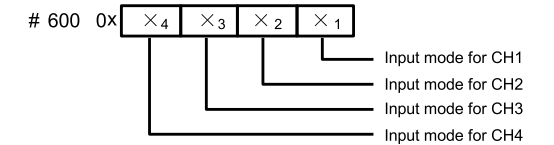

Figure 2-1 Mode setting element vs. channel

The exact meaning of the X in the channel mode is shown in Table 2-5.

Table 2-5 Meaning of X in input mode

Value of X	Information
0	-10V~+10V voltage input mode
1	-5V~+5V voltage input or -20mA~+20mA current input mode
3	Channel closed

For example, if #600 is written as '0x0103', the setting will be like this:

- Input channel 1 closed;
- Input channel 3 mode: -5V~+5V or -20mA~20mA (note the wiring difference in voltage and current, see 1.3 wiring);
- Input CH2, and CH4 mode: -10V~+10V.

5. BFM#650: output mode selection, controlled by the X1 in the 4-bit hexadecimal number 0xX4X3X2X1. The meaning of X is as follows:

Table 2-6 Meaning of X in output mode

Bit	Value	Information
X1	0	-10V ~ +10V voltage output mode
	1	0 ~ 20mA current output mode
	2	4 ~ 20mA current output mode
X2~X4		Reserved

6. BFM#700~BFM#703: average sampling times setting; setting range: 1~4096. Default: 8 (normal speed); choose 1 if high speed is needed.

7. BFM#900~919: channel gain and deviation settings, which are set using two-point method. D0 and D1 represent channel digital output, A0 and A1 represent actual channel input. A0 and A1 are in mV or μA, and each channel occupies 4 words. To simplify the setting operation without affecting functions, A0 and A1 are respectively fixed to 0 and the max value. Users cannot change them.

Note: If the channel input is current signal (-20mA~20mA), the present channel mode should be set to 1. Because the channel's internal measurement is based on voltage signal, current signals should be converted into voltage signals (-5V~5V) by the 250Ω resistor at the current input terminal of the channel. The A1 in the channel's characteristics setting is still in mV unit, i.e., 5000mV (20mA × 250Ω = 5000mV).

8. BFM#2000: AD conversion speed setting. 0: 15ms/channel (normal speed); 1: 8ms/channel (high speed). Setting BFM#2000 will restore BFM#1~#2 to the default, which should be noted in programming. If necessary, you can reset BFM#700~#703 after changing the conversion speed.

9. BFM#4094: module software version, displayed automatically as **Module Version** in **IVC1L-5AM Configuration** dialogue box of the host software, as shown in Figure 4-2.

11. BFM#4095: module ID. ID of IVC1L-5AM is 0x3141. The user program in PLC can use this ID to identify the module before transeiving data.

3 Characteristic Setting

3.1 Setting Analog Input Channel Characteristics

The input channel characteristic of IVC1L-5AM is the linear relationship between the channel's analog input A and digital output D. It can be set by the user. Each channel can be considered as the model shown in Figure 3-1. As it is of linear characteristic, the channel characteristic can be defined by just two points: P0 (A0, D0) and P1 (A1, D1), where D0 is the channel's digital output corresponding to analog input A0, and D1 is the channel's digital output corresponding to analog input A1.

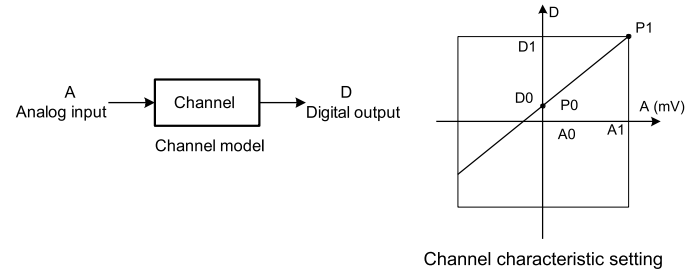

Figure 3-1 IVC1L-5AM input channel characteristic

To simplify the operation process without affecting functions, A0 and A1 are respectively fixed to 0 and the maximum value in the present mode. That is to say, in Figure 3-1, A0 is 0 and A1 is the maximum analog input in the present mode. A0 and A1 will change according to the mode when BFM#601 is changed. Users cannot change their values.

If you just set the channel mode (BFM#601) without changing the D0 and D1 of the corresponding channel, the channel characteristic vs. mode should be as shown in Figure 3-2. The A in Figure 3-2 is default.

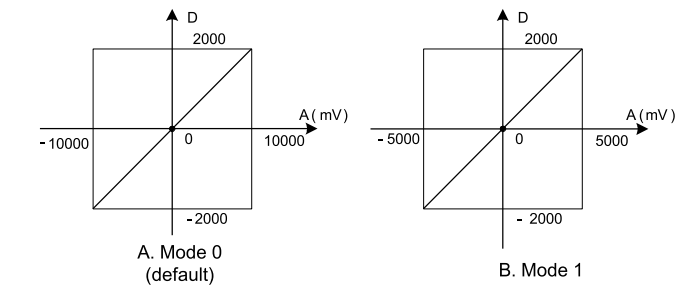

Figure 3-2 Default input channel characteristics in various modes

You can change the channel characteristic by changing D0 and D1. The setting range of D0 and D1 is -10,000~10,000. If the setting is outside this range, IVC1L-5AM will not accept it, but maintain the original valid setting. Figure 3-3 provides for your reference an example of changing channel characteristics.

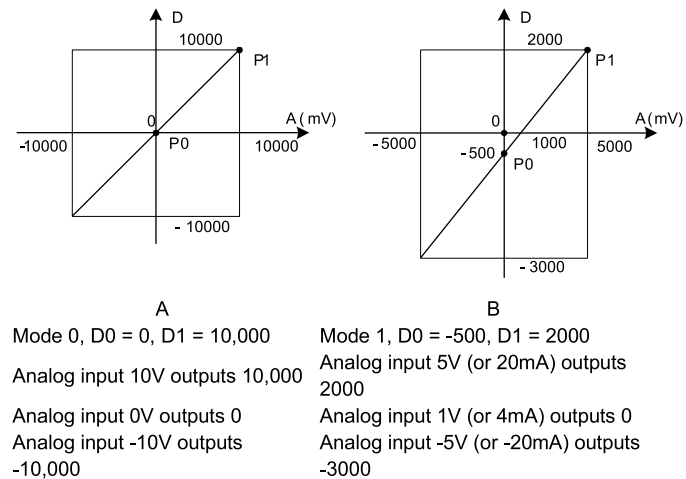

Figure 3-3 Changing input channel characteristics

3.2 Setting Analog Output Channel Characteristics

The analog output channel characteristic of IVC1L-5AM is the linear relationship between the channel's analog output A and digital input D. It can be set by the user. Each channel can be considered as the model shown in

Figure 3-4. Because it is of linear characteristic, the channel characteristic can be defined by just two points: P0 (A0, D0) and P1 (A1, D1), where D0 is the channel's digital input corresponding to analog output A0, and D1 is the channel's digital input corresponding to analog output A1.

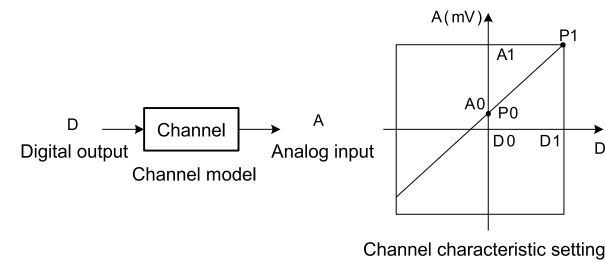

Figure 3-4 IVC1L-5AM output channel characteristic

To simplify the operation process without affecting functions, A0 and A1 are respectively fixed to 0 and the maximum value in the present mode. That is to say, in Figure 3-4, A0 is 0 and A1 is the maximum analog output in the present mode. A0 and A1 will change according to the mode when BFM#600 is changed. Users cannot change their values.

If you set the channel mode (BFM#600) without changing D0 and D1 of the corresponding channel, the channel characteristic vs. mode should be as shown in Figure 3-5. The A in Figure 3-5 is default.

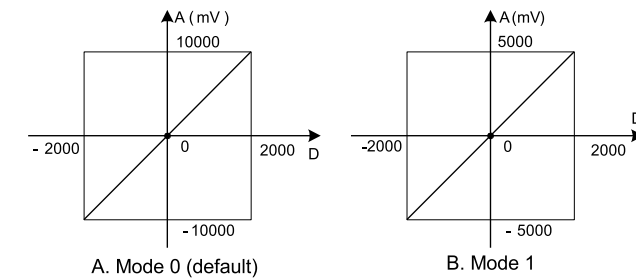

Figure 3-5 Default output channel characteristics in various modes

You can change the channel characteristic by changing D0 and D1. The setting range of D0 and D1 is -10,000~10,000. If the setting is outside this range, IVC1L-5AM will not accept it, but maintain the original valid setting. Figure 3-6 provides for your reference an example of changing channel characteristics.

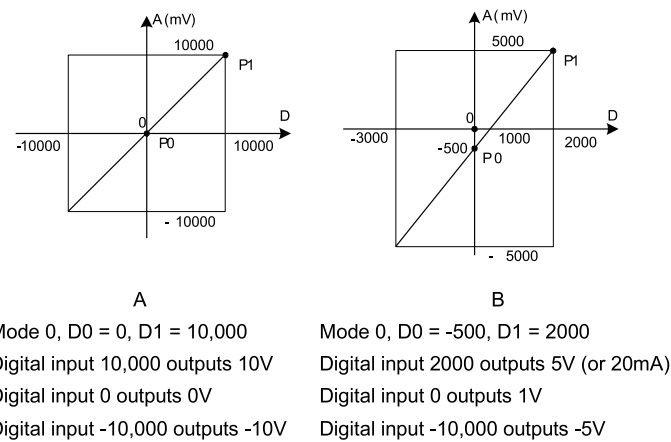

Figure 3-6 Changing output channel characteristics

4 Application Example

4.1 Basic Application

IVC1-5AM is selected for both IVC1L-5AM and IVC1-5AM in the system block. Example: The IVC1L-5AM module address is 1 (for the addressing of extension modules, see IVC Series PLC User Manual). Use its channels 1, 2, 3 and 4 for voltage signal input (-10V~10V), set the average sampling times to 8, and use data registers D1, D2, D3 and D4 to receive the average value; set output channel to mode 0 to output 10V voltage signal, and use D5 element. Set extension module type as shown in Figure 4-1, and set actual parameters of extension module. Figure 4-2 shows the setting of input channel 1 and output channel 1. Set the other three input channels respectively in the same way.

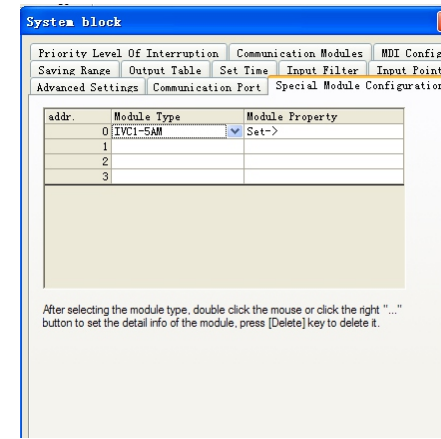

Figure 4-1 Setting special module type

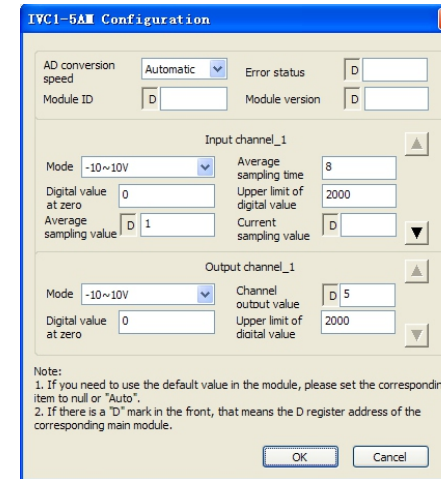

Figure 4-2 Setting special module parameters

To validate the parameter setting, you still need to compile and download the parameters. You can set and query D elements through the interface or by using the MOV instruction in user program.

MOV D5 2000 is a user program that makes the output channel output 10V.

For further details, see IVC Series PLC Programming Manual.

5 Operation Inspection

5.1 Routine Inspection

1. Check that the wiring of analog input meets the requirements (see 1.3 Wiring).
2. Check that the extension cable of IVC1L-5AM is properly inserted in the extension port.
3. Check that the 5V and 24V power supplies are not overloaded. Note: The digital circuit of IVC1L-5AM is powered by the basic module through the extension cable.
4. Check the application and make sure the operation method and parameter range are correct.
5. Set the IVC1L basic module to RUN state.

5.2 Fault Inspection

In case of abnormality, check the following items:

- the status of the POWER indicator
- ON: the extension cable is properly connected;
- OFF: check the extension cable connection and the basic module.
- the analog wiring
- the status of the 24V indicator
- ON: 24Vdc power supply normal;
- OFF: 24Vdc power supply possibly faulty, or IVC1L-5AM is faulty.
- the status of the RUN indicator
- Flash quickly: IVC1L-5AM in normal operation;
- Flash slowly or OFF: check the data in BFM#300.

Notice

1. The warranty range is confined to the PLC only.
2. **Warranty period is 18 months**, within which period INVT conducts free maintenance and repairing to the PLC that has any fault or damage under the normal operation conditions.
3. **The start time of warranty period is the delivery date of the product**, of which the product SN is the sole basis of judgment. PLC without a product SN shall be regarded as out of warranty.
4. Even within 18 months, maintenance will also be charged in the following situations:
 - Damages incurred to the PLC due to mis-operations, which are not in compliance with the User Manual;
 - Damages incurred to the PLC due to fire, flood, abnormal voltage, etc;
 - Damages incurred to the PLC due to the improper use of PLC functions.
5. The service fee will be charged according to the actual costs. If there is any contract, the contract prevails.
6. Please keep this paper and show this paper to the maintenance unit when the product needs to be repaired.
7. If you have any question, please contact the distributor or our company directly.

Shenzhen INVT Electric Co., Ltd.

Address: INVT Guangming Technology Building, Songbai Road, Matian, Guangming District, Shenzhen, China

Website: www.invt.com

All rights reserved. The contents in this document are subject to change without notice.